

Hickory Hills Park District Winter / Spring 2025 Program Guide

SENIOR LUNCHEONS



KARATE

EGG HUNT



FISHING DERBY

Registration Information

3 Ways To Register!

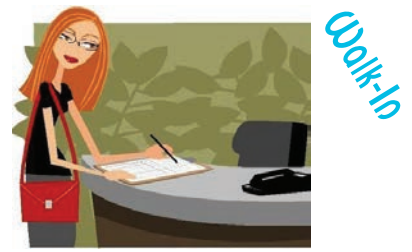
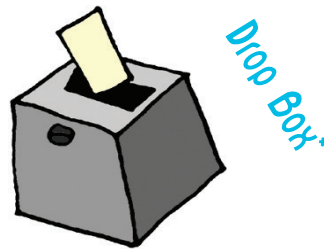
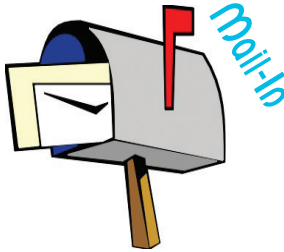

Resident Registration Begins Monday, December 2
Non-Resident Registration Begins Monday, December 9

Hickory Hills Park District
8047 W. 91st Place or 9100 S. 88th Avenue
Hickory Hills, IL 60457

*Place form and check in a sealed envelope and drop in the drop box located to the left of the front doors at the Cynthia Neal Center, 8047 W. 91st Pl. Available 24 hours a day.

Registration accepted until program/trip is filled. Refunds for special events and trips will be issued only if the program is cancelled by the Park District. (See page 23 for more information) NO refunds for medical reasons.

Please register as early as possible to avoid cancellations.



PROUDLY SUPPORTS
**Hickory Hills
Park District**

Strengthening the fabric of our community.

Our friendly bankers offer personal service and local lending solutions. Stop in or call us at 708-598-7400.

Khalid Ghori
Branch Manager

7800 W 95th St, Hickory Hills, IL 60457
708-576-7106
Khalid.Ghori@oldnational.com

oldnational.com



Member FDIC

2022 WORLD'S MOST
**ETHICAL
COMPANIES**
WWW.ETHISPHERE.COM
11-TIME HONOREE

ADMINISTRATIVE OFFICE

Cynthia Neal Administration &

Recreation Center

8047 W. 91st Place
Hickory Hills, IL 60457
(708) 598-1233

Krueger Park Recreation Center

9100 S. 88th Avenue
Hickory Hills, IL 60457
(708) 599-7337

OFFICE HOURS

Monday – Friday, 9 a.m. – 5 p.m.

WEB SITE

www.hhparkdistrict.org



PUBLIC BOARD MEETINGS

**3RD Monday of the Month at
the Cynthia Neal Center.
8047 W. 91st Place
at 7:00 p.m.**

Brochure can be available in an alternative format within 48-hours.

For the Hearing Impaired

T.D.D. Users call 800-526-0844. Able to use your own voice? Call 800-526-0857

BOARD OF COMMISSIONERS

A special thanks to the Commissioners who serve without any compensation.

Joshua Czarny
(2023 • 2025)

Patrick Kosnick
(1991 • 2025)

Sandra Morgan
(1990 • 2025)

Robert Peterson
(2015 • 2027)

Stephan Zalas
(2019 • 2027)

PARKS & RECREATION STAFF

Jennifer Fullerton..... Executive Director

Zachary Ingalls.....Maintenance Manager

Angel Sanchez.....Recreation Manager

Tammy Muth.....Business Manager

Sledding at Kasey Meadow Park

Sledding can be a hazardous recreational activity, so please sled safely and wisely this winter. No sledding after 9:00 p.m. Steps are provided for easy access, and we strongly encourage all sledders to use them. Think safety first and read the warning signs. Parents are responsible for supervision of their children. Always be aware of other sledders. NO METAL RUNNER SLEDS.



The following representatives may be contacted for information about their organizations

[Hickory Willow Swim Association](#)

Call: Tom Rieman 312-301-1870

[Hickory Hills Youth Baseball](#)

Call: George Czarnik 312-919-0295

Family Member Rate Policy

An immediate family member is defined as a married/spouse and/or child(ren) that are 24-years or younger and living in the same household.

Tennis Court Rules

- Hours: 9 a.m. until 10 p.m.
- Smooth soled shoes only.
- Park sponsored programs have priority.
- No bikes, skateboards, scooters, or roller blades allowed on courts.
- No food or drinks in court area.
- When others are waiting, please limit play to one hour.

Basketball Court Rules

- No alcoholic beverages.
- No bikes, skateboards, scooters, or roller blades allowed on courts.
- No profanity.
- Hanging on rims or dunking is prohibited.
- Loud music is prohibited.
- Do not relieve yourself on grounds.
- Be courteous when others are waiting.
- Court closes at dusk.
- Violations of these rules may result in the closing of the courts.

Special Recreation

Through a cooperative agreement between the Hickory Hills Park District and the South West Special Rec (SWSRA), children and adults who have a disability, handicap, or special needs, have the opportunity to participate in the special recreation program through the SWSRA. For more information, call the SWSRA Office at 708-389-9423. Visit SWSRA.org for brochure.

Brochure Distribution

The Hickory Hills Park District relies on the Bridgeview Post Office for mail delivery of our seasonal brochures. The Park District assumes no responsibility for mail delivery. If for some reason you do not receive a brochure, we encourage you to pick up a brochure at the Cynthia Neal Center or Krueger Park Recreation Center. A digital version of the brochure is available online at hhparkdistrict.org.

Rentals

The Hickory Hills Park District has limited activity rooms and field rentals available. A permit is necessary for any use of 7 or more people using our fields outdoors. Rentals are available at the Krueger Park picnic area and athletic fields for their corresponding sports.

For more information, including pricing and availability, call 708-598-1233.

**REFUNDS FOR SPECIAL EVENTS, ONE DAY PROGRAM/
EVENTS, AND TRIPS WILL BE ISSUED ONLY IF IT IS
CANCELLED BY THE PARK DISTRICT.**

Snowman Decorating Contest**305300-01**

Take home an 8" wooden snowman to decorate and compete in the most creative snowman contest. Participants will be able to paint, dress up or use your creative mind to transform frosty into your own family snowman. Make frosty into a Minion, Princess, Avenger, or any other character to best display as your family snowman. Participants will pick up and return their decorated snowman to Krueger Park for submission into the contest. All snowmen will be displayed for viewing in our Krueger Park lobby and be judged as best snowman for a chance to win a fabulous holiday family gift basket. Rules will be provided for the contest when you pick up your snowman. **Note: All snowmen can be picked up after December 6th, Monday – Friday 9:00 a.m. – 5:00 p.m. and must be returned for judging by December 20th. Participants do not need to be present during the judging and a winner will be notified by December 27th.**

Snowman pick up: December 6**Snowman drop off: December 20****Location Pick up: Krueger Park Recreation Center****Min/Max: 10/30****Fee: \$12 Resident, \$14 Non-Resident****Children's Christmas Party
(Hickory Hills Residents Only)****305323-01**

Children are invited to share in the Christmas Festivities sponsored by the Hickory Hills Park District and the City of Hickory Hills Community Affairs Commission. Children can visit with Santa, watch a terrific poms performance by our poms team, receive a balloon sculpture, and get their faces painted. Also, every child will receive a holiday candy bag as a parting gift from Santa. **Note: No registration is necessary for this fun-packed afternoon.**

Day & Date: Saturday, December 14**Time: 1:00 p.m.****Location: Krueger Park Gym****Fee: Free (Residents Only) All Ages****North Pole Calling****305324-01****(Hickory Hills Residents Only)**

He is making his list and checking it twice, looking for good boys and girls to call in Hickory Hills. Santa's elves dropped off registration forms at the Cynthia Neal Center, Krueger Park Recreation Center, and also available on your website. If you want Mrs. Claus or Santa to give your child a call before the "Big Day", return completed forms to the Cynthia Neal Center or Krueger Park Rec. Center before Tuesday, December 10th. Please make sure your child is home to receive his/her call on this date.

Day & Date: Friday, December 13 (1 night)**Time: 5:00 p.m. - 7:00 p.m.****Fee: Free (Residents Only)****Max: 20****Valentine's Day Ball****306300-01**

Join us for a Valentine's Day Ball! Mothers bring your son, and Fathers bring your daughter, for a night of dancing. Get ready for a night of family fun with games, contests, and sweet prizes. Bring out your dancing shoes and semi-formal attire. Participants will also get to enjoy open gym time while having fun dancing to music from our DJ. Pizza, pictures, and a D.J. will be included. Prepare to have some fun!

Day & Date: Friday, February 7**Time: 6:00 p.m. - 8:00 p.m.****Location: Krueger Park Gym****Min/Max: 30/60****Fee:****\$20 Resident****\$25 Non-Resident****(per one adult & one child)****(\$6 each additional child)****Spring Garage Sale****405429-01**

A 6 foot table in a 10 X 8 foot space will be provided for each registered seller. Each participant must provide their own cash box for change. The park district will advertise for this event. Concessions will be available.

NOTE: Crafters are welcome, but please, no professional vendors.**Day & Date: Saturday, April 26****Time: 8:00 a.m. - 1:00 p.m.****Location: Krueger Park Gym****Min/Max: 12/15****Ages: All Ages (Under 16 must be accompanied by an adult)****Fee: \$23 Resident, \$28 Non-Resident;****\$5 Additional table in your space (2 max)**

SPECIAL EVENTS

Pizza and Paint Night 436444-01

Join us for an evening of creating your own masterpiece and pizza! Bring your family and friends to make individual pizzas for each person while adding your own toppings and sauce. While waiting for your pizza to bake, we will be creating a canvas painting you will want to hang up in your own home! **NOTE: Fee includes painting materials, pizza, ingredients, and refreshments.**

Day & Date: Friday, March 7
Time: 6:00 p.m. - 7:30 p.m.
Ages: 16 years & up
Location: Krueger Park Activity Room A & B
Min/Max: 20/40
Fee: \$25 Resident, \$30 Non-Resident

Easter Basket Delivery

The Easter Bunny will deliver the beautiful basket (rain or shine) before he hops on his way to the next house delivery. All children will also receive a surprise gift. **NOTE: Parents must bring a filled Easter basket to Krueger Park Recreation Center between April 7th and April 11th. If your apartment is on the 2nd or 3rd floor, please meet the bunny on the ground level. Pictures of the bunny can only be taken from outside. Only residents of Hickory Hills and non-residents living within 2 miles of 91st & Roberts Road are eligible for delivery.**

Day	Tuesday	Wednesday
Date:	April 15	April 16
Time: 5:30 p.m.	405492-01	405492-07
5:45 p.m.	405492-02	405492-08
6:00 p.m.	405492-03	405492-09
6:15 p.m.	405492-04	405492-10
6:30 p.m.	405492-05	405492-11
6:45 p.m.	405492-06	405492-12

Fee: \$21 Per Delivery (Resident),
 \$26 Per Delivery (Non-Resident)
There will be an additional \$3 charge for each basket over 3 on a single visit.

“Santa Letters”

A personalized letter from Santa brings a smile to your child's face. Sign up to have your child receive a personalized letter from Santa. Visit our website (www.hhparkdistrict.org) for a form and more information about the Santa Letter.

Egg, Carrot, & Candy Hunt 405491-01 (Hickory Hills Residents Only)

Stop by for the fastest special event of the year. Collect candy, carrots and eggs in your basket or bag (residents only!). Separate areas will be set up for various age groups. Pictures with the Bunny are available from 1:45 - 2:30 p.m. for \$5.00. This is a rain or shine event. **NOTE: You can bring your own camera to take pictures with the Bunny, but you still need to pay \$5 for one picture.**

Day & Date: Saturday, April 12
Time: 1:30 p.m. promptly
Ages: 2-8 years
Location: Kasey Meadow Park
Fee: Free (Residents Only)

Annual Fishing Derby 405424-01

Awards will be given for the longest fish caught in each age division and a free raffle will be held for all participants. **YOU MUST FURNISH YOUR OWN POLE AND BAIT. NOTE: A valid fishing license is required for all participants 17 years and older. Register the day of the event. CHILDREN UNDER 12 YEARS OF AGE MUST BE ACCOMPANIED BY AN ADULT.**

EVENT SPONSORED BY THE SERTOMA CLUB OF HICKORY HILLS.

Day & Date: Friday, May 2
Time: 6:00 p.m. - 7:30 p.m.
Ages: 6 years & up
Location: Martin Park Pond, 89th Pl. & 78th Ave.
Fee: Free

Sensational Soup & Chili Day 305303-01

Come stay warm by trying a variety of 2 - 3 soups offered at this event. We will also have Xando's mouth watering chili. Crackers/bread, soda, & water will be provided. **NOTE: You must pre-register for this event. Deadline for registration is Noon on Wednesday, February 26th.**

Day & Date: Thursday, February 27
Time: 5:00 p.m. - 6:00 p.m.
Ages: All Ages (under 16 must be accompanied by an adult)
Location: Krueger Park Activity Room A & B
Min/Max: 32/50
Fee: \$13 Res. Adult, \$11 Resident (under 13),
 \$15 Non-Res. Adult, \$13 Non-Res. (under 13)
Children 5 and under are free



4

BIRTHDAY PARTY PACKAGES

Birthday Party Packages

Planning a birthday party? Let us do the work planning your child's birthday party. All birthday party packages are 2 hours long and available only on Saturdays & Sundays. Call for available days. Our birthday parties can accommodate kids of all ages and interests in an environment that is fun, safe, and truly unique! Various equipment and activities are available to enjoy. From parachutes, tunnels, and hula hoops for the younger kids to soccer balls, basketballs, and footballs for the older kids. We have what you need to make the party fun. **ALL PACKAGES INCLUDE:** Activity room set up of tables & chairs, juice boxes, pizza, gym setup of **MONSTER TRUCK BOUNCE**, sports activities, 2 hours of fun, and a party assistant. There is an additional fee for parties that need additional time.

NOTE: Parents will be responsible for invitations and helping with the cleanup.

A minimum of 2 adults per 10 children is needed to supervise the party with the party planner.

Registration must be done at least two weeks in advance. Full payment is due upon booking including a deposit of \$125, which will be refunded after the birthday party is completed and no issues or damage has been confirmed.

\$125 deposit will be kept if the birthday party is cancelled.

Location: Krueger Park Recreation Center, 9100 S. 88th Ave.

Fees: \$245 Resident (10-13 children); \$290 Resident (14-18 children)

\$255 Non-Resident (10-13 children); \$300 Non-Resident (14-18 children)

Dec. - Feb. 306332-01

Mar. - Apr. 406432-01

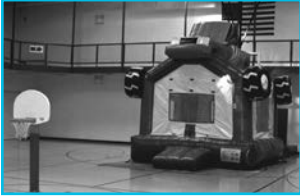

EARLY CHILDHOOD

Munchkin Open Gym

Does your toddler need to burn off excess energy? Enjoy some of our tunnels, mats, and mini cart. Watch your child play with other children while developing strength, coordination & agility. **NOTE: Parent or guardian must accompany the child.**

Dates: **January 8 - February 12 311302-02**
February 26 - April 2 411402-01

Day: **Wednesday**

Time: **10:30 a.m. - 11:30 a.m.**

Ages: **2-5 years**

Location: **Krueger Park Gym**

Min/Max: **6/12**

Fee: **\$26 Resident, \$31 Non-Resident**

Mini Gymnastics

Watch your kid go from cartwheels to confidence with lots of giggles along the way. Children get introduced to gymnastic equipment and gym rules. They learn basic gymnastic skills that work on strength building, gross motor skills and general coordination. They will practice and develop many gymnastics skills such as rolling in all directions as well as beginner handstands, cartwheels, and pullovers. The goal is for the kids to have fun and explore.

Dates: **January 13 - February 10**

Day: **Monday**

Time: **4:30 p.m. - 5:15 p.m. 311349-01**

5:15 p.m. - 6:00 p.m. 311349-02

Ages: **3 - 6 years**

Location: **Krueger Park Gym South**

Min/Max: **6/10**

Fee: **\$32 Resident, \$37 Non-Resident**

Runaway Circus 411404-01

Coming to town near you! Through obstacle courses, balloons and paddles, ball skills, parachute time and creative exercises. Children develop body awareness, build social skills, and expand their imaginations. These young participants deserve a vivacious and fun class that will set the stage for an active, healthy lifestyle.

Date: **February 13 - March 20**

Day: **Thursday**

Time: **1:00 p.m. - 1:45 p.m.**

Ages: **2-5 years**

Location: **Krueger Park Gym**

Min/Max: **6/10**

Fees: **\$33 Resident, \$38 Non-Resident**

Wiggles and Giggles 416406-01

Let's begin moving to the beat of the sound. This will be a moving and rhythmic class that will get the children up and on their feet. Throughout this class children will learn songs that they can sing at home. Also, the children will play instruments that they can use in class while moving to music. The children will move to various dance songs that are silly, energetic and fun.

Dates: **March 27 - April 24**

Day: **Thursday**

Time: **1:15 p.m. - 2:00 p.m.**

Ages: **2½-4 years**

Location: **Krueger Park Activity Room A**

Min/Max: **6/10**

Fee: **\$28 Resident, \$33 Non-Resident**

PRESCHOOL

5

We have designed a balanced preschool program ready to meet the educational, social, emotional, motor and creative needs of children 3 to 5 years. Preschool children will be introduced to letters, numbers, colors, shapes and other basic concepts. Pre-Kindergarten children will be introduced to phonics, pre-writing skills, fine motor skills, reading readiness and number concepts. Story-time, music activities, and seasonal art projects will be included in the program. Throughout the year the children will be playing, learning, growing and having fun with their peers. These programs are offered for half a year 3 hours a day, 5 days, 3 days or 2 days per week January through May. Children must be 3 years old by September 1, 2025. All children must be able to take care of their own bathroom needs.



Registration Information for 2025-2026

Registration for Preschool 2025-2026 begins March 4 for residents and March 10 for non-residents. Open House is scheduled for February 19 (6:00 - 7:00 p.m.). A detailed pamphlet with days, times, fees, etc. will be available at the end of January 2025. Office hours are Monday thru Friday, 9:00 a.m. - 5:00 p.m. All children must be the proper age by September 1st of the current school year and be able to take care of their own bathroom needs. Birth certificates and immunization records are required at the time of registration along with a \$100 non-refundable, non-transferable deposit. Please see our preschool handbook for the refund policy.

Half Year Option 2025

You are able to register for only half a year at a time. Students who are enrolled in the January - May option will be included in the farewell program at the end of the year.

Half Year Option January-May	M - F	M/W/F	T/TH
Fees due at time of registration	\$1118R/\$1128NR	\$655R/\$665NR	\$558R/\$568NR

Kindergarten Kid's Place

Is your child enrolled in half day preschool or kindergarten, and you need somewhere for them to go the rest of the day? You can sign them up for our before or after care program. Similar to the after school program, this program will only be held on full days of school (District 117). While the children are here they will work on their school work, play a variety of games, make craft projects, or play sports. Parents must contact District 117 for transportation price and arrangements before registering at the Park District. Each child must provide their own lunch. Any child picked up after 4:25 p.m. will be assessed a late fee (no exceptions). **NOTE: No refunds, credits, or transfers. For more details, call 708-598-1233. No after care on school scheduled days off. On team days, hours will be extended to accommodate you. Fees due by Thursday at 5:00 p.m. the week before or late fees apply.**

Before Care: 716711	After Care: 716712
Time: 8:45 a.m. - 12 Noon	Time: 12 Noon - 4:15 p.m.
Fee: \$86 Resident, \$90 Non-Resident per week	Fee: \$107 Resident, \$111 Non-Res. per week
Min/Max: 5/10	Location: Cynthia Neal Center Preschool Room

Mini School

Is your child ready for a little taste of preschool, but not quite ready to go the full 3 hours? Then Mini-School is the program for them! This program will introduce your child to the preschool environment in a shortened class time. Held in our preschool classroom with one of our preschool teachers, your child will experience a school setting, stories, songs, craft projects and fun with peers all in a smaller amount of time. **NOTE: If you want, you can register for one day or all days. NO CLASS April 18.**

Day/Dates: Tue., January 14 - February 11	716713-11	Tue., April 8 - May. 6	716713-19
Wed., January 15 - February 12	716713-12	Wed., April 9 - May. 7	716713-20
Thur., January 16 - February 13	716713-13	Thur., April 10 - May. 8	716713-21
Fri., January 17 - February 14	716713-14	Fri., April 4 - May. 9	716713-22
Tue., February 18- March 18	716713-15		
Wed., February 19 - March 19	716713-16	Time: 12:30 p.m. - 1:30 p.m.	
Thur., February 20 - March 20	716713-17	Ages: 2-4 Years	
Fri., February 21 - March 21	716713-18	Location: Cynthia Neal Center Preschool	
		Min/Max: 6/10	
		Fee: \$50 Resident, \$55 Non-Resident	

Morning School Program (December - June)

This program will be held before school begins for parents who have their children enrolled in School District 117. Staff will help participants prepare for school each day. Students who attend Glen Oaks Elementary School will be escorted to school by a Park Supervisor each morning. Students who are transported to school via a school bus must make transportation arrangements with the school district before enrolling your child. This program will only be held on full and half days of school (District 117). **NOTE: No refunds or credits on monthly fees (including for medical reasons). All participants must sign up for the entire month. No exceptions.**

Day:	Monday - Friday	Fee:	\$165 (December - 15 Days)	711715-05
Time:	7:00 a.m. - 8:45 a.m.		\$198 (January - 18 Days)	711715-06
Location:	Krueger Park Activity Room A & B		\$209 (February - 19 Days)	711715-07
Ages:	Grades 1st - 5th		\$154 (March - 14 Days)	711715-08
Min/Max:	8/30		\$209 (April - 19 Days)	711715-09
			\$231 (May - 21 Days)	711715-10
			\$33 (June 3 Days)	711715-11

After School Club 2024-25 “A Power Play! Beyond School Program” (December - June)

Come to Krueger Park and have a blast! This program is held after school for children that may need to go somewhere when school is over with. This program will only be held on full days of school (District 117). While the children are here they will work on their school work, play a variety of games, make craft projects, play sports, or even go outside to play. The students that attend Glen Oaks Elementary School will meet at the school with a Park Supervisor and will be walked over to Krueger Park at 2:45 p.m. then again after their Extended Day Program at 4:00 p.m. each day. The students from Dorn, Sorrick, Oak Ridge, and Conrady will be transported to Krueger Park. There is no charge if they are on the bus program. However if they are not, additional fees may apply if they wish to get transported by bus to Krueger Park. Students who are transported to school via a school bus must make transportation arrangements with the school district before enrolling your child. Each day snacks will be provided by the park. **No refunds or credits including for medical reasons. A transfer to a different day may only occur with a one week notice and must be approved by the Recreation Manager. New students need to be registered one week in advance (school transportation and park registration). Last minute changes cannot be made for students using school transportation. DAYS OFF: No After School Program on school scheduled days off. TEAM DAYS: On Team Days the After School Program will start at 1:45 p.m.**

Time: 3:00 p.m. - 6:00 p.m.
Location: Krueger Park Gym & Activity Room C
Fee: Glen Oaks - 711711; Dorn - 711712;
 Oak Ridge - 711713; Sorrick - 711714;
 Conrady - 711716 – \$17.00/day
 Same day registration will not be taken.



A HEALTHY PLATE
 MADE TO ORDER
www.4KIDSpLATE.com
 Toll Free: 1-877-783-KIDS
IAPD

Krueger’s Winter Spring Krew

School is out for Spring Break but you’re still working. Do you need a fun place for the kids to go for the day or the week? Krueger Park will be jumping with activities from 8:00 a.m. – 5:30 p.m. **NOTE: Don’t forget to pack a lunch and at least one water bottle. We will provide afternoon snacks. Must register in advance. NO SAME DAY REGISTRATION. The program may be cancelled due to low enrollment, so register early! NO REFUNDS OR CREDITS**

Winter Krew
Day & Date: Thurs. December 26 311311-03
 Fri. December 27 311311-04
 Thurs. January 2 311311-05
 Fri. January 3 311311-06
Fee: \$43 Resident, \$48 Non-Resident (Daily)

Spring Krew
Day & Date: Monday, March 24 411411-04
 Tuesday, March 25 411411-05
 Wednesday, March 26 411411-06
 Thursday, March 27 411411-07
 Friday, March 28 411411-08



Fee: \$43 Resident, \$48 Non-Resident (Daily)
 \$195 Resident, \$200 Non-Resident
Time: 8:00 a.m. - 5:30 p.m.
Ages: 5-12 years
Location: Krueger Park Activity Room C
Min/Max: 8/25

EARLY CHILDHOOD/YOUTH ACTIVITIES 7

Gingerbread House Decorating 306301-01

Come out and bring your family to create Gingerbread houses! Get in the holiday spirit and come explore a wide variety of Gingerbread houses to make using candy and frosting. We will provide all the materials needed to create your personalized houses.

Date: Wednesday, December 18
Time: 6:00 p.m. – 7:00 p.m.
Ages: All Ages
Location: Krueger Park Activity Room C
Min/Max: 8/15
Fee: \$12 Resident, \$14 Non-Resident (per household)

Junior Tennis Stars

421461-01

Play exciting games and learn how to hit a forehand, backhand, volley, overhead smash and serve. Racquets will be provided.

NOTE: Classes will be held outdoors.

Dates: April 14 - May 19
Day: Monday
Time: 4:10 p.m. - 5:00 p.m.
Ages: 5-7 years
Location: Krueger Park Tennis Courts
Min/Max: 7/10
Fee: \$51 Resident, \$56 Non-Resident



Little Dribblers

Even future stars have to learn the basics of dribbling, passing, shooting and rebounding. Players will learn the game of basketball by participating in exciting drills and playing fun games. Baskets will be lowered for these stars. **NOTE: Fee includes a t-shirt.**

Dates: January 8 - February 19 321321-01
 March 5 - April 16 421421-01
Day: Wednesday
Time: 4:15 p.m. - 5:00 p.m.

Ages: 4-7 years
Location: Krueger Park Gym
Min/Max: 8/12
Fee: \$52 Resident, \$57 Non-Resident

Pre "T" Ball - Indoors 411403-01

Your child can learn the basics of T-Ball before they actually take the field this spring/summer. Children will get a head start on learning how to run the bases, throw a ball, hit a ball, and play the game. All participants will receive their first baseball hat to be ready for the T-Ball season. **NOTE: Children must have their own mitt.**

Date: April 3 - May 1
Day: Thursday
Time: 3:30 p.m. - 4:15 p.m.
Ages: 3-5 years
Location: Krueger Park Gym
Min/Max: 6/10
Fee: \$41 Resident, \$46 Non-Resident

Jr. T-Ball 111152-01

Jr. T-Ball is designed to be instructional only. Children will get the chance to learn the basics in hitting, catching and base running. Kids will learn how to hit a soft baseball off a Tee. This program will focus on teaching a new skill each week. **NOTE: Children must have their own mitt. Fee includes a hat, t-shirt, awards and a pizza party at the last game.**

Dates: May 7 - June 11
Day: Wednesday
Time: 6:30 p.m. - 7:30 p.m.
Ages: 4-6 years
Location: Krueger Park Baseball Field
Min/Max: 18/27
Fee: \$47 Resident, \$52 Non-Resident

Holi-"Day Off" Krew

While you are at work and your kids are off of school, enroll them in a program that is sure to keep them busy all day. Children will participate in a variety of activities in our gym and activity room that will be sure to keep out of trouble at home. **NOTE: Don't forget to pack a lunch each day. We will provide afternoon snacks. Must register in advance.**

Day & Date: Monday, January 6 311311-01
 Monday, January 20 311311-02
 Monday, February 17 311311-07
 Monday, March 3 411411-01
 Monday, April 21 411411-02

Time: 8:00 a.m. - 5:30 p.m.
Ages: 5-12 Years
Location: Krueger Park Activity Room C
Min/Max: 8/25
Fee: \$43 Resident, \$48 Non-Resident (Daily)

S.T.E.A.M. Lab**426412-01**

Have an interest in science or creating experiments then dive into science during this fun, explosive, bubbling, colorful, and exciting new class! All children become engineers as they explore different topics, including Science, Technology, Engineering, Art and Mathematics. Each week, children will conduct exciting experiments and challenges that require critical thinking.

Dates: February 18 - March 18
Day: Tuesday
Time: 4:30 p.m. - 5:30 p.m.
Ages: 5-8 years
Location: Krueger Park Activity Room A & B
Min/Max: 8/12
Fee: \$45 Resident, \$50 Non-Resident

Among Us Real Life Experience 406409-01

Does your child love the game Among Us? If so, we have the program for you! Come join us in a one-day program where we play the game Among Us around the park! We will explain the rules and concepts of the game and then have the kids recreate the game in real life! At the end of the game we will provide pizza and a drink for your child.

Day & Date: Monday, March 10
Time: 6:00 p.m. - 7:30 p.m.
Ages: 8-12 years
Location: Krueger Park Gym
Min/Max: 10/20
Fee: \$19 Resident, \$21 Non-Resident

MMA - Mixed Martial Arts

Students will train in a positive atmosphere, learn how to defend themselves and gain valuable life skills – all while having fun! This is done through our structured monthly curriculum. Students will focus on Boxing, Kickboxing, Jujitsu and Wrestling technique each month, as well as two “Mat Chat’s” where we cover important lessons such as focus, confidence, and gratitude.

Dates: Session I: January 9 - February 27 321308-02 **Ages:** 5-11 years
 Session II: March 13 - May 1 421408-01 **Location:** Krueger Park Gym South
Day: Thursday **Min/Max:** 6/20
Time: 6:00 p.m. - 7:00 p.m. **Fee:** \$114 Resident, \$119 Non-Resident

I've Got Game

Kids will become familiar with passing, dribbling, shooting and the basic rules of the game. Teamwork, good sportsmanship, and fun are all stressed in this exciting class. **NOTE: Fee includes a t-shirt.**

Dates: January 8 - February 19 321323-01
 March 5 - April 16 421423-01
Day: Wednesday
Time: 5:00 p.m.- 6:00 p.m.
Ages: 7-9 years
Location: Krueger Park Gym South
Min/Max: 8/15
Fee: \$52 Resident, \$57 Non-Resident

Rim Seekers

This 7 week class is the perfect class for the future basketball star. This class is going to be game based so your child will get to know the flow of playing in a real basketball game. Games will be played every week and will be paused throughout the game for teaching. Other games like 3pt contests, knockout, and free throw contests will also be played. Team work, good sportsmanship and fun are all stressed in this exciting class.

NOTE: Fee includes a t-shirt.
Dates: January 8 - February 19 321378-01
 March 5 - April 16 421478-01
Day: Wednesday
Time: 5:00 p.m.- 6:00 p.m.
Ages: 10-14 years
Location: Krueger Park Gym North
Min/Max: 8/15
Fee: \$52 Resident, \$57 Non-Resident

Creative Horizons**426401-01**

In this mixed media art class children will learn about painting, drawing, and sketching using watercolors and oil pastels. They will create new projects each week by different artists all over the world. All tools and materials will be provided by Hickory Hills Park District.

Date: February 6 - March 6
Day: Thursday
Time: 5:45 p.m. - 6:45 p.m.
Ages: 7-12 years
Location: Krueger Park Activity Room C
Min/Max: 6/12
Fee: \$43 Resident, \$48 Non-Resident

Hit & Run ~ Tennis 421458-01

These group lessons are designed for students who love the game of tennis. Hone your skills on our courts with fellow tennis enthusiasts.

Dates: April 14 - May 19
Day: Monday
Time: 5:00 p.m. - 6:00 p.m.
Ages: 8-12 years
Location: Krueger Park Tennis Courts
Min/Max: 7/10
Fee: \$51 Resident, \$56 Non-Resident

Homeschool Gym

Join us for homeschool gym, a dynamic program designed for families to enjoy physical activity in a supportive and social environment. Our program focuses on promoting fitness and teamwork through a variety of fun games and exercises. It offers a great opportunity for children to stay active, make friends, and develop skills.

Day: Mondays & Thursdays
January 13 - February 17 321305-01
Date: March 3 - April 10 421405-01
Time: 10:30 a.m. - 11:30 a.m.
Ages: 6-12 years
Location: Krueger Park Gym
Min/Max: 6/12
Fee: \$50 Resident, \$55 Non-Resident
 \$6 Walk-In

Homeschool Craft

326300-01

Does your child like to create things from imagination? Then come and join us for a class where your child can explore a blend of creativity and hands-on fun! Children can unleash their imagination as they engage in a wide range of crafts such as making a bird feeder, snow globes and many more!

Date: January 16 - February 20
Day: Thursdays
Time: 11:30 a.m. - 12:15 p.m.
Ages: 6-12 years
Location: Krueger Park Activity Room C
Min/Max: 6/12
Fee: \$35 Resident, \$40 Non-Resident

Flag Football

421444-01

Catching and throwing are only part of Flag Football. Come and learn the basics of how to throw and catch a ball while learning the rules for playing Flag Football. Participants will form teams each week to play a game while understanding simple techniques to improve their game. **Note: Fee includes a t-shirt and equipment. No tackling allowed during this sport.**

Dates: February 25 - April 1
Day: Tuesday
Time: 4:30 p.m. - 5:30 p.m.
Ages: 9-13 years
Location: Krueger Park Gym
Min/Max: 8/24
Fee: \$55 Resident, \$60 Non-Resident

Krueger Gardeners

426410-01

Spring gardens are magical places, full of new life and little mysteries just waiting to be discovered. Join for an adventure where kids will plant a seed and watch it grow through this 4-week course, where they'll learn all about gardening through play, exploring and nature-related crafts. Each week, children will explore plant parts and uncover what plants need to grow.

Dates: April 2 - April 23
Day: Wednesday
Time: 4:00 p.m. - 4:45 p.m.
Ages: 6-9 years
Location: Krueger Park Activity Room C
Min/Max: 6/12
Fee: \$36 Resident, \$41 Non-Resident

Glow in the Dark Dodgeball

421486-01

Turn down the lights and put on some neon! Come out and enjoy a fun new way of playing dodgeball in the dark! A night full of fun, laughter, and pizza. Glowsticks will be given to wear, and pizza and refreshments will be served. Come with a bright shirt on and get ready to dodge, dip, and dive.

Date: March 21
Day: Friday
Time: 6:30 p.m. - 8:00 p.m.
Ages: 9-12 years
Location: Krueger Park Gym
Min/Max: 10/20
Fee: \$13 Resident, \$15 Non-Resident

Horseback Riding Lessons

Staff will teach riders for pleasure or to show competitively. All riders must sign a release waiver and wear safety helmet while riding. Helmets are available to rent for \$2 per time. All riders must wear long pants. No shorts. All lessons are fully-supervised.

NOTE: Bring your receipt to the stables to set-up time and day. Call stables at 708-598-7718 for more information or visit their website at newtraditionsridingacademy.com.

Dates: December-February 301310-01
 March-May 401410-01
Location: New Traditions Riding Academy
 10100 S. Kean Ave.
Ages: 7 years & up
Fees: Beginner: \$265 (5x Lessons)
 Beginner: \$530 (10x Lessons)
 Non-residents pay \$10 more to the prices listed

Friday Hoops

Play basketball with your friends or just come out to shoot around. Pay at the door and enjoy fast break games. A maximum of 25 players are allowed in the gym at one time. **NOTE: All players must fill out a Friday Hoops form before participating.**

Dates: January 10 - May 30

Day: Friday

Grades/Times: 5th - 8th Grade 421436-01

4:00 p.m. - 6:00 p.m.

9th-12th Grade 431436-01

6:30 p.m. - 8:30 p.m.

Location: Krueger Park Gym

Min/Max: 12/25

Fee: \$6 (each day pay at the door, 5th - 8th)
\$8 (each day pay at the door, 9th - 12th)

Cash Only!

NO Hoops February 7, March 21, April 18,25

Junior Wednesday Night Soccer 421419-01

This soccer league is for players 5 - 8 years of age. Each team will consist of 7 - 8 players. League will consist of 1 practice and 7 scrimmages. **NOTE: All players will receive a t-shirt. Parents interested in coaching should contact the Recreation Manager at 708-599-7337.**

Dates: January 15 - March 5

Day: Wednesday

Game Times: 6:15 p.m. or 7:00 p.m.

Ages: 5-8 years

Location: Krueger Park Gym

Min/Max: 21/30

Fee: \$53 Resident, \$58 Non-Resident

**Wednesday Night Soccer 421487-01**

This soccer league is for players 9 - 12 years of age. Each team will consist of 6 - 8 players. Each team will play 8 scrimmages. **NOTE: All players will receive a t-shirt. Parents interested in coaching should contact the Recreation Manager at 708-599-7337.**

Dates: January 15 - March 5

Day: Wednesday

Game Times: 7:00 p.m. or 7:45 p.m.

Ages: 9-12 years

Location: Krueger Park Gym

Min/Max: 21/28

Fee: \$53 Resident, \$58 Non-Resident

Indoor Soccer - Little Kickers 311330-01

This introductory soccer league is a shortened version of our youth soccer program and is designed to help transition children into team play. Modified, non-competitive scrimmages will be played. This league will be run in a low key environment and coaches will be more hands on during games. **Birth date as of September 1, 2024** will determine division placement. A birth certificate may be requested if there is a question of a child's age. Scrimmages and practice times will vary from week to week and may be adjusted depending on number of teams formed. Coaches needed! **Your coach will notify you to let you know what time your first practice will be held.** Requests to be with another player will be taken on a separate request form when registering through November 11 but are not guaranteed. **Game times/practice times are approximate and are dependant on number of teams in each division.**

Dates: December - March

Day: Saturday

Time: 9:00 a.m. - 11:00 a.m.

Ages: 4-5 Years

Location: Oak Lawn Park District
9401 S. Oak Park Ave., Oak Lawn, IL

Min/Max: 12/14

Fee: \$81 Resident, \$91 Non-Resident

Co-Ed Youth Indoor Soccer

Teams will be formed by a blind draft policy and will compete against teams from neighboring park districts. Teams will practice in December and will begin play in January. Scrimmages and practice times will vary week to week, and may be adjusted depending on the number of teams formed. **Birth date as of September 1, 2024** will determine age division. Birth certificates may be requested if there is a question of a child's age. Coaches needed! Sign up early! **Your coach will notify you to let you know what time your first practice will be held.** Requests to be with another player will be taken on a separate request form when registering through November 11 but are not guaranteed.

NOTE: Game times/practice times are approximate and are dependant on number of teams in each division.

Dates: December - March

Location: Oak Lawn Park District
9401 S. Oak Park Ave., Oak Lawn, IL

Min/Max: 12/16

Fee: \$113 Resident, \$123 Non-Resident

Day:	Ages:	Time:	
Saturday	6-7	11:00 a.m. - 3:00 p.m.	321317-01
Saturday	8-9	3:00 p.m. - 8:00 p.m.	321317-02
Sunday	10-11	1:00 p.m. - 3:00 p.m.	321317-03
Sunday	12-13	3:00 p.m. - 6:00 p.m.	321317-04

Full Day & Half Day Camps

Come and join us for a summer full of fun! We offer Full Day, Half Day AM & PM camps. Your child will spend each day participating in games, sports activities, crafts, theme days/weeks and much more! Children must be able to participate independently in age appropriate activities and follow verbal instructions. **Note: Snacks will be provided. NO Refunds or Credits**

Sessions Dates	Full Day Camp			Half Day Camp AM		Half Day Camp PM	
	Session #	Pog. #	Rate R/NR	Pog. #	Rate R/NR	Pog. #	Rate R/NR
Session I: June 9 - June 27	126179	01	\$330/\$335	09	\$213/\$218	12	\$213/\$218
Session II: June 30 - July 18	126179	02	\$308/\$313	10	\$199/\$204	13	\$199/\$204
Session III: July 21 - August 8	126179	03	\$330/\$335	11	\$213/\$218	14	\$213/\$218

Day: Monday-Friday

Times: 9:00 a.m. – 4:00 p.m. (Full Day)

8:30 a.m. – 12:00 p.m. (Half Day AM)

12:30 p.m. – 4:00 p.m. (Half Day PM)

Ages: 6 - 13 years (must be 6 by June 9)

Location: Krueger Park Rec. Center

Min/Max: 60/90 Full Day

Min/Max: 14/24 Half Day **NO Camp July 4**

Sunrise & Sunset Camp – Full/Half Day Camp Supplements

Are camp hours not long enough for your busy schedule? This camp is for those who need extended hours before and/or after regular camp time. **Note: All campers must be registered for Full Day Camp, Half Day Morning at Krueger Park (for Sunrise Camp), or Half Day Afternoon at Krueger Park (for Sunset Camp). No Refunds or Credits!**

Session Dates	Sunrise Camp			Sunset Camp	
	Session #	Pog. #	Rate R/NR	Pog. #	Rate R/NR
Session I: June 9 - June 27	126180	01	\$119/\$124	04	\$119/\$124
Session II: June 30 - July 18	126180	02	\$111/\$116	05	\$111/\$116
Session III: July 21 - August 8	126180	03	\$119/\$124	05	\$119/\$124

Day: Monday - Friday

Times: 7:30 a.m. – 9:00 a.m. (Sunrise camp)

4:00 p.m. – 6:00 p.m. (Sunset camp)

Ages: 6 – 13 years (must be 6 by June 9)

Location: Krueger Park Rec. Center

Min/Max: 8/24

NO Camp July 4

Little Rascals Camps

Get your little one ready for a summer of fun and excitement with our Little Rascals camp. Children will participating in games, sports activities, crafts, theme days/weeks and our Splash pad! Choose a morning or afternoon camp for your child. Include the “Lunch Bunch” program in your child’s day to extend some time for them to have lunch with other kids. **Note: A lunch must be provided for participants that are signed up for the Lunch Bunch program. Children must be able to participate independently in age appropriate activities and follow verbal instructions. ALL CHILDREN MUST BE TOILET TRAINED. NO Refunds or Credits.**

Session Dates	Little Rascals Camp AM			Lunch Bunch		Little Rascals Camp PM	
	Session #	Pog. #	Rate R/NR	Pog. #	Rate R/NR	Pog. #	Rate R/NR
Session I: June 9 - June 27	126179	06	\$185/\$190	19	\$79/\$84	16	\$185/\$190
Session II: June 30 - July 18	126179	07	\$173/\$178	20	\$69/\$74	17	\$173/\$178
Session III: July 21 - August 8	126179	08	\$185/\$190	21	\$79/\$84	18	\$185/\$190

Day: Monday - Friday

Times: 9:00 a.m. – 11:45 a.m. (AM camp)

11:45 a.m. - 12:15 p.m. (Lunch Bunch)

12:15 a.m. – 3:00 p.m. (PM camp)

Ages: 3 – 6 years (must be 3 by June 9)

Location: Cynthia Neal Center

Min/Max: 14/24

NO Camp July 4

Recreational Volleyball

This instructional program for boys and girls will stress overhand serving, passing, setting, footwork and fun. Games will be held each week.

Time p.m.:		Beginner	Intermediate	Ages:	10-16 years
Dates:	Jan 16 - Feb 27	321376-01	321376-02	Location:	Krueger Park Gym
	Mar 13 - Apr 24	421476-01	421476-02	Min/Max:	7/12
Day:	Thursday			Fee:	\$50 Resident, \$55 Non-Resident

**Violin Band****426406-01**

Experience the fun and thrills of performing with other musicians. Perform popular classical music and holiday songs during this 12-week program.

Dates:	January 12 - March 30
Day:	Sunday
Time:	12:15 p.m. - 1:15 p.m.
Ages:	5 years & up
Instructor:	Barbara Satora
Min/Max:	8/16
Fee:	\$72 Resident, \$77 Non-Resident
Location:	Krueger Park Activity Room C
	\$10 discount for each additional family member up to 3

Private Voice & Piano Lessons

These 30-minute private lessons are designed for beginners and intermediate level learners. Voice lessons will focus on developing voice range, pitch, tone production, breath control, stage presence and more. Piano lessons will teach the fundamentals of note reading, hand positioning, and fingering techniques. All lessons will take place at Palos Music Instruction. Upon registration, the instructor will contact you to arrange the lesson time and further details for your lessons. **NOTE: Books may be purchased from the instructor directly as needed. Students must have a piano or electric keyboard at home for practice purposes. This is an 8 week program (1 lesson per week)**

	Piano	Voice
Dates:	January 6 - March 1	426494-01 406427-01
	March 3 - April 26	426494-02 406427-02
Day:	Monday - Saturday	
Time:	10:00 a.m. - 8:00 p.m. (30 minute Slot)	
Ages:	5 years & up	
Min/Max:	2/10	
Location:	Palos Music Instruction	
	10604 S. Roberts Rd.	
Fee:	\$175 Resident, \$180 Non-Resident	
	\$10 discount for each additional family member up to 3	

**Violin Vibrations**

Our instructor, Barbara Satora, a former private teacher for the Chicago Youth Symphony Orchestra, will teach hand positioning, notes, and memorization- just to name a few things. Sessions last 45 minutes. Note: Fee includes lessons, music books, and theory sheets. Students that need to purchase or rent their instrument must attend an orientation that is set up by the instructor. Call 708-599-7337 to schedule an orientation appointment. No make-up classes after the last class is in session.

Dates:	January 11 - February 16	326313-03
	March 1 - April 6	426413-01
Location:	Krueger Park Activity Room C	
Min/Max:	8/16	
Fee:	\$194 Resident, \$199 Non-Resident	
	\$10 discount per additional family (3 Max)	
Dates:	January 11 - February 16	326313-04
	March 1 - April 6	426413-02
Fee:	2 siblings together for a 1-hour session	
	\$244 Resident, \$254 Non-Resident	
Day:	Saturday or Sunday	
Time:	8:15 a.m. - 6:00 p.m.	
Ages:	4 years & up	

Private Guitar Lessons - 30 Minutes

These lessons are for beginner to advanced (acoustic or electric guitar). Instructor will structure progressive lessons based on students' individual needs and interest. **NOTE: Each student will be placed in a 30-minute (private lesson) time slot. All students must bring a guitar to class. Call Frank at Palos Music Instruction at 708-974-8002 to set up day & time for lessons. This is a 8-week program (1 lesson per week).**

Dates:	January 6 - March 1	436495-01
	March 3 - April 26	436495-02
Day:	Monday - Saturday	
Time:	10:00 a.m. - 8:00 p.m.	
	(30 minute time slot)	
Ages:	5 years & up	
Location:	Palos Music Instruction	
	10604 S. Roberts Rd.	
Min/Max:	6/10	
Fee:	\$175 Resident, \$180 Non-Resident	
	\$10 discount for each additional family member up to 3	

ILLINOIS SHOTOKAN KARATE

13

Illinois Shotokan Karate Club is Chicagoland's premier karate school taught under the instruction of John DiPasquale, four-time National Champion and President of the American Shotokan Karate Association. **Beginner students will not be permitted to register into the current session after the second class has met.** Registration for continuers through advanced students will be accepted after the start date, but the full class fee is required plus the late fee.

Uniforms and belt-testing are options available through the ISKC instructor. At additional cost

PRE-KARATE (4-6 years) • Young children will develop flexibility, strength, and coordination in fun, yet disciplined, activities. This program is specifically designed for growing minds and bodies to enhance memory and agility, Watch your child's confidence blossom and their skills improve.

YOUTH/ADULT KARATE (7 years and up) • ISKC's Karate classes offers a good mix of strength training, with cardiovascular and flexibility exercises. Students increase their coordination, agility and poise, as well as learn lasting personal safety skills. They also benefit from the mental stimulation of learning the choreographed moves of the kata and the discipline of conforming to the class rules.

Winter Session - 12 Weeks			
Tuesday Classes			
January 7 - March 25		\$174 Res./\$179 Non-Res.	
Program #	Time	Level/Color	Age
301313-02	6:00 - 7:00 p.m.	Beginner/Novice White - Orange	7 & Up
301313-03	7:00 - 8:00 p.m.	Intermediate Yellow - Purple	7 & Up
301313-04	8:00 - 9:00 p.m.	Advanced Brown - Black	7 & Up

Saturday Classes			
January 4 - March 22		\$174 Res./\$179 Non-Res.	
Program #	Time	Level/Color	Age
301313-01	9:00 - 9:55 a.m.	Beginner/Continuer Pre-Karate	4 - 6
301313-05	10:00 - 11:00 a.m.	Beginner/Novice White - Blue	7 & Up
301313-06	11:00 a.m. - Noon	Intermediate Green - Black	7 & Up

SPRING CLASSES - 10 Weeks			
Tuesday Classes			
April 1 - June 3		\$145 Res./\$150 Non-Res.	
Program #	Time	Level/Color	Age
401413-02	6:00 - 7:00 p.m.	Beginner/Novice White - Orange	7 & Up
401413-03	7:00 - 8:00 p.m.	Intermediate Yellow - Purple	7 & Up
401413-04	8:00 - 9:00 p.m.	Advanced Brown - Black	7 & Up

Saturday Classes			
April 5 - June 7		\$145 Res./\$150 Non-Res.	
Program #	Time	Level/Color	Age
401413-01	9:00 - 9:55 a.m.	Beginner/Continuer Pre-Karate	4 - 6
401413-05	10:00 - 11:00 a.m.	Beginner/Novice White - Blue	7 & Up
401413-06	11:00 a.m. - Noon	Intermediate Green - Black	7 & Up

Any registration for Tuesday classes received after 5:00 p.m. on the first day of class & registration for Saturday classes received after 5:00 p.m. on the Friday before the first class, will be charged a \$15 late fee.

These classes are an excellent way to spend quality time with your child, while conditioning muscles, developing coordination, and improving cardiovascular fitness. **Fees are per person.**

NOTE: Participants should wear loose fitting clothes to class. Through the cooperation of the Oak Lawn Park District and the Illinois Shotokan Karate Club, we are able to offer Hickory Hills residents additional classes at the Oak Lawn Park District at a resident rate. Registration for Oak Lawn classes is taken at Oak Lawn Park District, 9401 S. Oak Park Ave., Oak Lawn, IL. 708-857-2420.

Residents of Hickory Hills or Oak Lawn receive resident rate.

Classes are held at Krueger Park Recreation Center, 9100 S. 88th Ave.



MMA - Mixed Martial Arts (For Teens)

Join us for the most effective styles of martial arts, infused with lessons on character development. Students 11 - 15 will train in a positive atmosphere, learn how to defend themselves and gain valuable life skills. Students will focus on boxing and kickboxing techniques (kicking, footwork, and defense), judo/wrestling technique (take-downs and defending take-downs) and "Mat Chat" (the personal development topic of the program).

Session I: January 9 - February 27 **341311-01**
Session II: March 13 - May 1 **441411-01**
Day: Thursday
Time: 7:00 p.m. - 8:00 p.m.
Ages: 11 - 15 years
Instructor: Victory Family MMA
Location: Krueger Park Gym
Min/Max: 8/20
Fee: \$114 Resident, \$119 Non-Resident

Indoor Pickleball Open Gym 441440-01

Join this really fun and popular game! It's a little like badminton, a little like tennis and a little like table tennis. The rules are short and simple and the racquets and balls are light weight. Played on a badminton sized court (two on a side) with a low net, the first team to score 11 points wins. Please bring your own paddles and balls, if you have them. **No Class March 10**

Dates: January 6 - April 28
Ages: 21 & Older
Day: Monday
Location: Krueger Park Gym
Time: 7:30 p.m. - 9:00 p.m.
Min/Max: 8/20
Fee: \$5 Resident, \$7 Non-Resident

Hatha Yoga

Hatha Yoga is about finding a balance between the body, mind, and spirit. Hatha yoga uses body poses, breathing techniques and meditation in hopes of bringing flexibility, and manage stress. **NOTE: It is always advisable, especially if pregnant, to consult a physician before undertaking any physical activity. Bring your mat and water bottle.**

Dates: January 6 - February 24 **343320-02**
 March 17 - May 5 **443420-01**
Day: Monday
Time: 6:30 p.m. - 7:30 p.m.
Ages: 16 years & up
Instructor: Pam Lawrence
Location: Krueger Park Activity Room A & B
Min/Max: 8/14
Fee: \$72 Resident, \$77 Non-Resident

Wednesday Night Hoops**741775-02**

Play basketball with your friends or just come out to shoot around. No spectators. Anyone not following the rules will be asked to leave with no refund or being suspended from the program. Every player must show a picture ID with name address, and age listed. **NOTE: Pay at the door each night.**

Dates: March 12 - April 30
Day: Wednesday
Time: 7:30 p.m. - 9:00 p.m.
Ages: 21 years & up
Location: Krueger Park Gym
Min/Max: 8/20
Fee: \$6 Resident, \$8 Non-Resident (each day)
Cash Only!

Instructional Pickleball

Have you ever thought of trying to play Pickleball but not sure how to play? Well now is the time to learn the popular trend called Pickleball. It's a little like badminton, a little like tennis and a little like table tennis. The rules are short and simple and the racquets and balls are light weight. Played on a badminton sized court (two on a side) with a low net, the first team to score 11 points wins. We will instruct you on the rules and how to play the game. **No Class March 10**

Dates: January 13 - February 10 **341340-02**
 February 24 - March 31 **441440-02**
Day: Monday
Time: 6:30 p.m. - 7:30 p.m.
Ages: 16 years & up
Location: Krueger Park Gym
Min/Max: 8/16
Fee: \$47 Resident, \$52 Non-Resident

**Volleyball Tournament (Teens) 431402-01**

Come and play in our one-day teen volleyball tournament. You can sign up your team (6 players) or sign up individually to be assigned a team to play on. Each player on the winning team will receive a prize. **NOTE: Refreshments will be given to all the players.**

Day & Date: Thursday, March 6
Time: 5:30 p.m. - 8:30 p.m.
Ages: 13 - 17
Location: Krueger Park Gym
Min/Max: 6/8 teams
Fee: \$30 (per team)
 \$6 (per individual)

FITNESS CENTER

15

Resident rate is for Hickory Hills & Palos Hills Residents.

Fitness Center Membership

	<u>Resident</u>	<u>Non-Res.</u>	<u>Program #</u>
Annual Individual Rate (16 - 61 years)	\$195.00	\$260.00	741794-01
Married/Spouse or couple with formalized commitment agreement in the same household	\$285.00	\$385.00	741794-01
Add An Additional Family Member	\$90.00	\$125.00	741794-01
Annual Senior Rate (62 years and over)	\$115.00	\$155.00	751793-01
Annual Senior Married/Spouse Rate	\$180.00	\$220.00	751793-01
6-Month Membership (consecutive months)	\$130.00	\$165.00	741794-02
6-Month Membership (consecutive, Married/Spouse)	\$200.00	\$270.00	741794-02
Additional Family Member 6-Month Membership (consecutive months)	\$70.00	\$105.00	741794-02
Winter Break College Students (December 2 nd - January 5 th)	\$35.00	\$40.00	741794-06
Hydro Massage Wellness - 3-Months Unlimited (Member) (limit one use per day)	\$25.00	\$25.00	741702-01
Hydro Massage Wellness - 3-Months Unlimited (Non-Member)(limit one use per day)	\$35.00	\$35.00	741702-01
Guest Pass- Valid on date of purchase only	\$6.00	\$8.00	741794-03
Daily Punch Card (6 Punches)	\$36.00	\$48.00	741794-04

Walking Track Membership

	<u>Resident</u>	<u>Non-Res.</u>	<u>Program #</u>
Individual (16 - 61 years)	\$65.00	\$90.00	741755-01
Senior (62 years & over)	\$50.00	\$90.00	751756-01
Daily Pass Individual	\$2.00	\$3.00	741756-01

Memberships, unless otherwise stated, are good for one year from date of registration.

Fitness Center Holiday Hours

December 24	8:00 a.m. - 12:00 p.m.
December 25	Closed
December 31	8:00 a.m.- 12:00 p.m.
January 1	8:00 a.m.- 12:00 p.m.
April 18	5:30 a.m.- 6:00 p.m.
April 20	Closed
May 26	8:00 a.m.- 12:00 p.m.

Fall Fitness Center / Walking Track Hours (December 1 - May 25)

Monday - Friday - 5:30 a.m. - 9:00 p.m.
 Saturday - 7:00 a.m. - 4:00 p.m.
 Sunday - 8:00 a.m. - 3:00 p.m.

Family Member Rate Policy:

An immediate family member is defined as a married/spouse, and/or child(ren) living in the same household, that is 24 years old or younger (14 - 24 years).

MEMBERSHIP CATEGORIES INCLUDE:

Fitness Center Memberships - Includes fitness center, locker rooms, & walking track access.

Walking Track Memberships - Allows member access to walking track & locker rooms only.

Individual Members are defined as adults 16 and over.

Additional family members are defined as children (14-24 years) residing in the same household.

All family memberships will expire on the same day.

If you have any medical concerns (including pregnancy), consult your physician before using the walking track and/or fitness center equipment. No refunds/credits will be made on any memberships or daily passes. No refunds for any medical reasons.



Sore Muscles? Stress? Hydro Massage!

Relax and refresh with a warm water massage!

Membership	Unlimited 3-month	Single use
	15 mins (once per day)	15 mins (each use)
Fitness Members	\$25	\$4
Non-Members	\$35	\$5

Benefits of Hydro Massage:

- *Relieve Arthritis
 - *Increase flexibility
 - *Relieve muscle soreness
 - *Speed up recovery
 - *Decrease general pain
 - *Increase circulation
- Note:** You don't have to get undressed. You can enjoy your massage fully clothed and comfortable.

Locker Rental Fees:

Resident: 6-Months	\$15	Men's	741700-01
		Women's	741700-02
Non-Resident: 6-Months	\$20	Men's	741700-01
		Women's	741700-02

To replace a lost or stolen fitness center card, the fee is \$7 per card.

Bingo Night

Enjoy a refreshing beverage with snacks and dinner while you engage in a variety of bingo games (18-25). Prizes will be awarded for each game winner. Sit down and enjoy the company of your friends as we'll do the rest. Every player will get to create their own Bingo card for the grand prize game! **NOTE: Every player will receive multiple cards. Fee includes prizes, snacks, dessert, refreshments (coffee, pop, & water), and dinner.**

Day & Date: Tuesday, February 11 355375-02
 Tuesday, April 1 455475-01
Time: 5:30 p.m. - 8:00 p.m.
Ages: 21 years & up
Location: Krueger Park Activity Rooms A & B
Min/Max: 30/50
Fee: \$21 Resident, \$23 Non-Resident

Left, Center, Right

LCR, short for "Left, Center, Right", is a simple dice game to play. Participants roll three dice marked with 3 individual dots, Left, Center, and a Right. The point of the game is to roll a dot(s) in order to win the game. **NOTE: You will be treated to pizza, popcorn, refreshments, and a chance to win some fabulous prizes.**

Day & Date: Friday, January 17 346321-01
 Friday, April 4 446421-01
Time: 7:00 p.m. - 9:00 p.m.
Ages: 21 years & up
Location: Krueger Park Activity Room C
Min/Max: 10/24
Fee: \$16 Resident, \$18 Non-Resident

Farkle

446436-01

Enjoy an evening of Dice! Farkle is a dice game in which the goal is to get the highest score on the highest round of play. You will be treated to dinner and refreshments and a chance to win some fabulous gift certificates. **NOTE: If you do not know how to play, come early and we will teach you before we get started. Dinner and refreshments will be served.**

Day & Date: Friday, March 28
Time: 7:00 p.m. - 9:00 p.m.
Ages: 21 years & up
Location: Krueger Park Activity Room C
Min/Max: 10/24
Fee: \$16 Resident, \$18 Non-Resident

Grand Bingo

455475-02

Enjoy this special Bingo event where everyone is **guaranteed a prize**. Come for a chance to win fabulous prizes and a chance to win the "Grand Prize". Sit down and enjoy the company of your friends as we'll do the rest. **NOTE: Every player will receive multiple cards. Fee includes prizes, snacks, dessert, refreshments (coffee, pop, & water), and lunch.**

Day & Date: Saturday, May 17
Time: 1:00 p.m.- 4:00 p.m.
Ages: 21 years & up
Location: Krueger Park Activity Rooms A & B
Min/Max: 30/50
Fee: \$24 Resident, \$26 Non-Resident

Phase 10

The goal of the game is to complete all ten phases, one round at a time. At the end of a round players will add up their score based on the number and type of cards left in their hand. The goal is to have the lowest score at the end of the game. Watch out, if you don't complete your phase in a round, you must repeat the phase in the next round! Gather some friends and play. Try different strategies to achieve the lowest score you can, but most of all have fun! You will be treated to dinner and refreshments and a chance to win some prizes.

Day & Date: Friday, February 21 346320-01
Time: 7:00 p.m. - 9:00 p.m.
 Thursday, April 17 446420-01
Time: 11:30 a.m. - 2:00 p.m.
Ages: 21 years & up
Location: Krueger Park Activity Room C
Min/Max: 10/24
Fee: \$16 Resident, \$18 Non-Resident

Bunco Blast

Enjoy an evening of Dice! Sign up to play this old parlor dice game at Krueger Park. You will be treated to pizza, popcorn, refreshments, and a chance to win some fabulous gift certificates and prizes. **NOTE: Beginners are welcome.**

Day/Date: Friday, February 28 346374-01
Time: 11:00 a.m. - 2:00 p.m.
Day/Date: Friday, May 9 446474-01
Time: 7:00 p.m. - 9:00 p.m.
Ages: 21 years & up
Location: Krueger Park Activity Room C
Min/Max: 8/24
Fee: \$16 Resident, \$18 Non-Resident

“21” Double Down

Do you love the game of “Blackjack”? We will enjoy lunch, refreshments, and dessert before trying our luck in cards. Many prizes will be awarded after the competition. All levels are welcome!

Day & Date: **Thursday, January 16** **356305-01**
Thursday, March 6 **456405-01**
Thursday, May 15 **456405-02**

Time: **11:30 a.m. - 2:00 p.m.**

Ages: **21 years & up**

Location: **Krueger Park Activity Room C**

Min/Max: **15/22**

Fee: **\$17 Resident, \$19 Non-Resident**

Texas Hold'em Poker Tournament

Join us for this popular style of poker where prizes will be awarded after the competition. New players are welcome to play and learn while enjoying a boxed lunch and refreshments.

Day & Date: **Thursday, January 30** **346306-01**
Thursday, April 3 **446406-01**

Time: **11:30 a.m. - 2:00 p.m.**

Ages: **21 years & up**

Location: **Krueger Park Activity Room C**

Min/Max: **12/16**

Fee: **\$17 Resident, \$19 Non-Resident**

Open Gym - Basketball (Unscheduled) 741775-01

Any open gym for basketball (not designated) will require a small fee to play. Call 708-599-7337 for availability. 18 years & older. **Fee: \$5 Resident/\$7 Non-Resident CASH ONLY**

Acting for Adults 446402-01

This class is intended for both beginning and more advanced actors. Focus will be on developing the actor's instrument, as well as work on scripted material, including scene work and audition pieces. Actors will be encouraged to give each other feedback, so that they are fully participating at all times.

Dates: **March 5 - April 23**

Day: **Wednesday**

Time: **6:30 p.m. - 8:30 p.m.**

Ages: **18 years & up**

Location: **Krueger Park Activity Room C**

Min/Max: **8/16**

Fee: **\$88 Resident \$93 Non-Resident**

Pinochle

Do you like playing cards? How about Pinochle? The other participants will teach you how to play the entertaining game of Pinochle. Once you learn, you'll be hooked forever.

Day & Date: **Friday, February 14** **356302-01**
Tuesday, March 25 **456402-01**

Time: **11:30 a.m. - 2:00 p.m.**

Ages: **50 years & up**

Location: **Krueger Park Activity Room C**

Min/Max: **8/30**

Fee: **\$12 Resident, \$14 Non-Resident**



Progressive Rummy

Progressive Rummy is a very easy game to learn. Each hand has a different wild card. Register for this enjoyable day at Krueger Park.

Day & Date: **Friday, January 10** **356345-01**
Friday, April 11 **456445-01**
Friday, May 2 **456445-02**

Time: **11:00 a.m. - 2:30 p.m.**

Ages: **50 years & up**

Location: **Krueger Park Activity Rooms A & B**

Min/Max: **20/35**

Fee: **\$12 Resident, \$14 Non-Resident**

Dominoes

This is an easy game with simple rules, but the fun is limitless. Lunch will be served around noon.

Day & Date: **Friday, February 7** **356316-01**
Friday, March 14 **456416-01**
Friday, April 25 **456416-02**

Time: **11:00 a.m. - 2:30 p.m.**

Ages: **25 years & up**

Location: **Krueger Park Activity Rooms A & B**

Min/Max: **20/35**

Fee: **\$12 Resident, \$14 Non-Resident**

Tropical Show Lunch 356380-01

Join us in January for a heart-warming Tropical show by Edizon Dayao. Edizon is a multi talented person who got his start after moving to Hawaii from the Philippines. **NOTE: Includes lunch, refreshments, dessert & entertainment.**

Day & Date: Tuesday, January 21**Time:** 12:00 p.m. - 2:00 p.m.**Ages:** 50 years & up**Location:** Krueger Park Gym**Min/Max:** 80/125**Fee:** \$10 Resident, \$13 Non-Resident**The "Kings" Luncheon** 356319-01

A feast fit for a King or Queen! Our meal will be sure to satisfy the hungriest of royalties. We will enjoy a finger licking meal that will require little to no utensils. We might even get a visit from the "King" himself. **NOTE: Includes lunch, refreshments, dessert & entertainment.**

Day & Date: Tuesday, February 18**Time:** 12:00 p.m. - 2:00 p.m.**Ages:** 50 years & up**Location:** Krueger Park Gym**Min/Max:** 80/125**Fee:** \$10 Resident, \$13 Non-Resident**Irish Luck Luncheon**

456423-01

Wear your green and join us as we celebrate St. Patrick's Day, a day late at Krueger Park Rec. Center, with corn beef and cabbage and the trimmings. Join us on this day where we can all be a little Irish for the day. Note: Fee includes lunch, dessert and entertainment.

Day & Date: Tuesday, March 18**Time:** 12:00 p.m. - 2:00 p.m.**Ages:** 50 years & up**Location:** Krueger Park Gym**Min/Max:** 80/125**Fee:** \$10 Resident, \$13 Non-Resident**Pastapalooza Luncheon** 456422-01

Pastapalooza is a pasta lovers luncheon. At this luncheon sample a variety of pasta dishes along with a few sides. This meal will surely fill your pasta needs.

NOTE: Fee includes lunch, dessert, refreshments & entertainment.

Day & Date: Tuesday, April 15**Time:** 12:00 p.m. - 2:00 p.m.**Ages:** 50 years & up**Location:** Krueger Park Gym**Min/Max:** 80/125**Fee:** \$10 Resident, \$13 Non-Resident**Fiesta Luncheon**

456435-01

Let's have one more fiesta before summer begins with a Mexican feast of tacos, rice and beans. We will play some Bingo for fabulous prizes and a few surprises.

NOTE: Fee includes lunch, dessert and entertainment.

Day & Date: Tuesday, May 20**Time:** 12:00 p.m. - 2:00 p.m.**Ages:** 50 years & up**Location:** Krueger Park Gym**Min/Max:** 80/125**Fee:** \$10 Resident, \$13 Non-Resident

MATURE ADULT EXERCISE

Easy Does It

Easy Does It incorporates circuit and strength training with a cardio blend designed to improve your overall health, balance, strength, and endurance. Classes are geared towards seniors and you set your own pace. Try it. . . like it. . . love it. **NOTE: Dumbbells and steps will be provided. No Class January 21, February 18, April 15.**

Dates: January 14 - March 6

March 20- May 8

353307-02

453407-01

Ages: 50 years & up**Location:** Cynthia Neal Center**Day:** Tuesday & Thursday**Time:** 10:00 a.m. - 10:45 a.m.**Min/Max:** 10/20**Fee:** \$98 Resident, \$103 Non-Resident

ADULT EXERCISE/GREAT ESCAPES

19

Chair Yoga

Chair Yoga is a unique yoga style that adapts yoga positions and poses through creative use of a chair. The chair replaces the mat and becomes an extension of the body. Bring a water bottle with you. Anyone can practice yoga regardless of age, experience, or level of flexibility – we can all benefit from yoga.

Dates: January 6 - February 24 351320-02
March 17 - May 5 451420-01
Day: Monday
Time: 5:15 p.m. - 6:15 p.m.
Ages: 50 years & up

Instructor: Pam Lawrence
Location: Krueger Park
Activity Room A & B
Min/Max: 10/24
Fee: \$72 Resident,
\$77 Non-Resident



Four Winds Casino Resort

Join us for an exciting day at Four Winds Casino Resort in New Buffalo, Michigan! Enjoy over 3,000 of the latest slots (1¢ to \$100) and a large selection of table games at this beautiful Midwest casino. **NOTE: Fee includes 52-54 Passenger Bus, \$15 instant credit/free slot play and a \$10 food coupon. Everyone must bring a state ID to the casino.**

Price Drop!

Day & Dates: Friday, January 31 304304-01
Friday, March 21 404404-01
Time: Depart 8:30 a.m.; Return 4:15 p.m.
Ages: 21 years & up
Location: Bus departs from Krueger Park
Rec. Center 9100 S. 88th Ave
Min/Max: 40/50
Fee: \$31 Resident, \$36 Non-Resident

American Place Casino (Waukegan, IL.)

344302-01

Join us and visit this new temporary casino located in Waukegan, IL. Featuring hundreds of slot machines, dozens of table games, and a sports book. American Place Casino is a gamer's paradise. Participants will receive a \$10 slot play and an additional \$10 slot play if you are a new member to American Place Casino. **NOTE: Trip includes transportation and additional slot play amounts.**

Day & Date: Friday, February 28
Time: Depart 9:00 a.m.; Return 5:00 p.m.
Ages: 21 years & up
Location: Bus departs from Krueger Park
Rec. Center 9100 S. 88th Ave
Min/Max: 35/54
Fee: \$34 Resident, \$39 Non-Resident



Shot Glasses & Glass Making 444404-01 (Lake County, IL.)

Take a unique behind the scenes tour of Lake County's glass maker. The tour begins with a demonstration of the glass making techniques used to make shot glasses and more glass materials. Lunch will be held at a local Lake County Establishment. **NOTE: Fee includes transportation, lunch, and tour and an individual handcrafted shot glass.**

Day & Date: Thursday, March 6
Time: Depart 8:30 a.m., Return 4:30 p.m.
Ages: 21 years & older
Location: Transportation departs from Krueger
Park Rec. Center 9100 S. 88th Ave
Min/Max: 28/32
Fee: \$124 Resident, \$129 Non-Resident

CATS (Chicago Broadway) 404406-01

The most beloved musical in theater history brings the colorful world of Cats to the stage. Inspired by a collection of poems by T.S. Eliot, Cats, the iconic musical by Andrew Lloyd Webber, is a well-loved fantastical journey into the world of Jellicle Cats. Light on dialog, but full of captivating dance, rousing music and singsong poetry, the show won the Tony for Best Musical and Best Original Score. **NOTE: Tickets are at the Paramount Theatre in Aurora, IL. and are in the lower balcony.**

Day & Date: Thursday, May 22
Time: Depart 5:30 p.m., Return 10:30 p.m.
Ages: All Ages (Under 16 must be accompanied by an adult)
Location: Transportation departs from Krueger
Park Rec. Center 9100 S. 88th Ave-
Min/Max: 18/20
Fee: \$116 Resident, \$121 Non-Resident

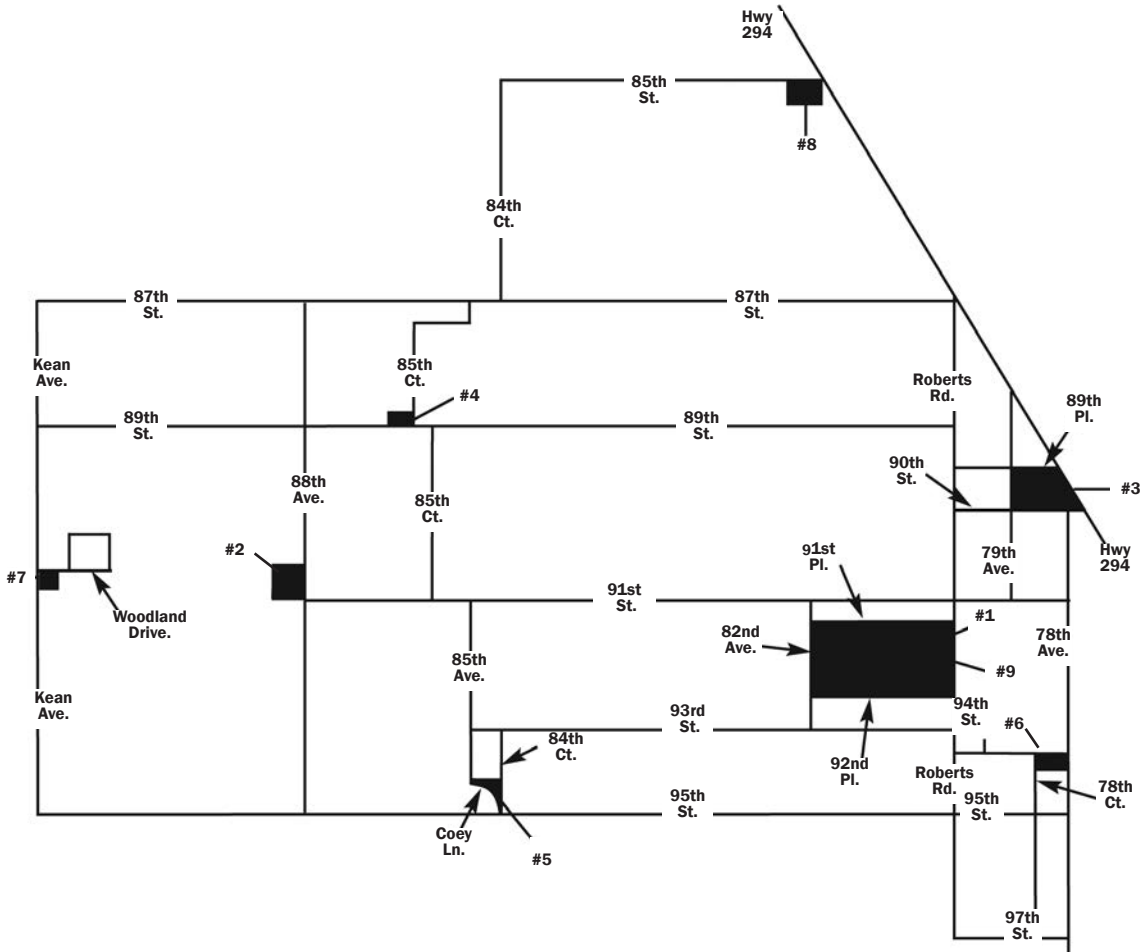

- Administrative Office
- Basketball Court (Outside)
- Ball Diamond (Lit)
- Ball Diamond (Not Lit)
- Gymnasium
- Maintenance Garage
- Activity Room
- Multi-Purpose Room
- Parking Facilities
- Picnic Area
- Play Apparatus
- Recreation Center
- Fishing Pond
- Soccer/Football Field
- Tennis Courts (Lit)
- Tennis Courts (Not Lit)
- Walking Trail (Per Lap)
- Outdoor Fitness Station
- Splash Pad
- Indoor Walking Track/
Fitness Center
- Skate Park
- Performance Stairs
- Total Acreage

#1. Cynthia Neal Center Kasey Meadow Park 8047 W. 91st Pl.	1	1	2	1	1	1	3	1	2	1	2	2	1/2 Mile	1	1	1	1	17.0
#2. Krueger Park 9100 S. 88th Ave.	1	1	1	3	1	1	1	1	1	2	1/4 Mile	1	10.0					
#3. Martin Park 89th Pl. & 78th Ave.	2	3	1	1	1/8 Mile	6.9												
#4. Petkiewicz Park 89th St. & 85th Ct.	1	2	1.75															
#5. Doug Osborne Park 9400 S. 84th Ct.	1	1	1	1	1.0													
#6. Memorial Park 94th St. & 78th Ave.	1	1	1	1.0														
#7. Woodland Park Woodland Dr. & Kean Ave.	1	.5																
#8. Prairie View Park 82nd Ave. & 85th St.	1	1	1	1	7/8 Mile	4.0												
#9. Maintenance Facility 9156 Roberts Rd.	1	.275																

REGISTRATION FORM

Mail-in or Drop-off registration at Hickory Hills Park District,
Cynthia Neal Administration & Recreation Center, 8047 W. 91st Pl.,
or Krueger Recreation Center, 9100 S. 88th Avenue, Hickory Hills, IL 60457.

Last Name: _____ First Name: _____ Date: _____

Home Phone: _____ Work Phone: _____ Cell Phone: _____

Address: _____ City: _____ Zip: _____

Emergency Phone : _____ E-mail Address: _____

If you or your child need any special accommodations to participate in this program, or if your child has an IEP, please check box. Please note on a separate piece of paper and call (708) 598-1233 to discuss special accommodations. Indicate shirt size only if shirt is included in program fee.

Participant's First Name	Participant's Last Name	Date of Birth	Gender	Program #	Program Title	Fee
Office Use Only: F WI WIA MI DB R NR _____ Staff initial _____ Date Received						

FAMILY MEMBER RATE POLICY

An immediate family member is defined as a married/spouse and/or child(ren) that is 24 years or younger, living in the same household.

WAIVER & RELEASE IMPORTANT INFORMATION

The Hickory Hills Park District is committed to conducting its recreation programs and activities in a safe manner and holds the safety of participants in high regard. The Park District continually strives to reduce risks and asks that all participants follow safety rules and instructions that are designed to protect the participant's safety. However, participants and parents/guardians of minors registering for a program/activity must recognize that there is an inherent risk of injury when choosing to participate in recreational activities or programs. You are solely responsible for determining if you or your minor child/ward are physically fit and/or skilled for the activities contemplated by this agreement. It is always advisable, especially if the participant is pregnant, disabled in any way or recently suffered an illness, injury or impairment, to consult a physician before undertaking any physical activity.

WARNING OF RISK

Recreational activities are intended to challenge and engage the physical, mental and emotional resources of each participant. Despite careful and proper preparation, instruction, medical advice, conditioning and equipment, there is still a risk of serious injury when participating in any recreational activity. Understandably, not all hazards and dangers can be foreseen. Depending on the particular activity, participants must understand that certain risks, dangers and injuries due to inclement weather, slip and falls, poor skill level or conditioning, carelessness, horseplay, unsportsmanlike conduct, premises defects, inadequate or defective equipment, inadequate supervision, instruction or officiating, and all other circumstances inherent to indoor recreational activities exist. In this regard, it must be recognized that it is impossible for the Hickory Hills Park District to guarantee absolute safety.

WAIVER & RELEASE OF ALL CLAIMS AND ASSUMPTION OF RISK

Please read this form carefully and be aware that in signing up and participating in this program/activity, you will be expressly assuming the risk and legal liability and waiving and releasing all claims for injuries, damages or loss which you or your minor child/ward might sustain as a result of participating in any and all activities connected with and associated with this program/activity (including transportation services, when provided).

I recognize and acknowledge that there are certain risks of physical injury to participants in this program/activity, and I voluntarily agree to assume the full risk of any and all injuries, damages or loss, regardless of severity, that my minor child/ward or I may sustain as a result of said participation. I further agree to waive and relinquish all claims I or my minor child/ward may have (or accrue to me or my child/ward) as a result of participating in this program/activity against the Hickory Hills Park District, including its officers, officials, agents, volunteers and employees. By signing this waiver, I hereby grant permission for any pictures taken of participants to be used for publicity or in brochures related to the programs of the Hickory Hills Park District.

I have read and understand the refund policy as stated on the General Information pages. I have read and fully understand the above important information, warning of risk, assumption of risk and waiver and release of all claims. If registering via fax, my facsimile signature shall substitute for and have the same legal effect as an original form signature. If registering a minor participant, I further attest that I have read the above to my minor child/ward.

X _____
Signature of parent, guardian, or adult participant 18 years or older _____ Date _____
Participation will be denied if the signature of adult participant or parent/guardian and date are not on this waiver.

REGISTRATION INFORMATION

- Walk up registration is accepted at the Cynthia Neal Center & Krueger Park Recreation Center when the building is open. After 5 p.m., drop off registration is accepted with a check payment. **No receipt will be mailed to you unless you request one.** You may use the drop box located to the left of the front doors at the Cynthia Neal Center. This drop box is accessible 24 hours a day.
- All mail-in registration will be accepted at the Cynthia Neal Center, 8047 W. 91st Place. All mail-in registration will be processed the day it is received during registration dates. Please be sure to include the mail-in registration form, and fill-in all necessary information, as well as signing the waiver on the registration form. Mail the registration form along with appropriate program fees, and include non-resident fee when applicable. Make checks payable to the Hickory Hills Park District. Please do not send cash. The park district is not responsible for lost or late mail/drop box registration.
- No eligible participant shall, on the basis of race, sex, creed, national origin or disability be denied equal access to program activities, services or benefits or be limited in the exercise of any right, privilege advantage or opportunity.
- Registration fees for late registration will not be prorated and late fees may be added.
- All in person registration is taken at the Cynthia Neal Center, located at 8047 W. 91st Place, or Krueger Park Recreation Center, located at 9100 S. 88th Avenue.
- No one will be enrolled in any program unless the registration form is properly signed.
- All registration is on a first come, first serve basis, and no space will be held unless the fee is paid. Proof of residency must be shown at the time of registration. When programs are filled, a waiting list will be started, and an attempt will be made to create additional classes.
- A \$37 service charge will be assessed for any checks returned by the bank, along with any charge backs from a credit/debit card.
- **Programs that have not reached minimum enrollment one week prior to the first meeting may be cancelled. Register as early as possible for all classes, programs, special events, & trips.**

SOCCER COURT RULES

CAUTION: Soccer is a high risk recreational activity with inherent risks of serious injury.

- Hours: 9 a.m. until dusk.
- Do not climb on soccer goals.
- No food or drinks. No alcohol, drugs or smoking/vaping in court area.
- Park District programs have priority.
- No bikes, skateboard, scooter, or roller blades on the court.
- If others are waiting be courteous and limit time to 1-hour
- No pets allowed.
- No profanity.
- Limit play to 1-hour if others are waiting.

INFORMATION ABOUT INSURANCE

The park district is committed to conducting its recreation programs and activities in the safest manner possible. Participants and parents or guardians registering their children in recreation programs must recognize that there is an inherent risk of injury when choosing to participate in recreation activities. The park district continually strives to reduce such risks and insists that all participants follow safety rules and instructions. Please recognize that the park district does not carry medical accident insurance for injuries sustained in its programs. The cost of this insurance would make program fees prohibitive.

Due to insurance regulations, children are not allowed in adult classes with parents. The Park District is also not responsible for children left unsupervised while a parent attends a class.

CHILD PICK-UP POLICY

To insure the safety of the children, we ask you to drop off and pick up your child(ren) promptly when classes are over. Also, please instruct your child(ren) to wait inside the building for you when class is over. Instructors/Coaches will not allow child(ren) under 10 years of age to leave without an adult or older sibling. Children, whose parents fail to pick them up before a specified time, will be taken to the office until a parent arrives. If a child is not picked up within 10 minutes, the park district will contact the child's emergency phone number. If the park district cannot reach anyone, the child will be held until closing time or for a maximum of two hours, whichever comes first. There will be a \$5.00 late fee per child assessed for every 10 minutes you are late picking up your child(ren) after class. All fees must be paid in cash before your child can continue in the class or register for any future classes. If no one can be contacted at closing time of the building, or by the maximum time limit of two hours, the police will be contacted and your child will be taken into protective custody until a parent or guardian can be notified. Once under police jurisdiction, the park district is not responsible for any legal ramifications. If you are late and the building is closed, and you are unable to reach park district staff:

1. Contact the people on your emergency form to verify whether or not any of them have your child.
 2. Call the police (708-598-1313) if you cannot locate your child.
- More than two late pick-ups may result in your child being dropped from the program. No refund will be given.

SKATE PARK RULES**OPEN APRIL 1 - OCT 31**

- Hours of operation: **9 a.m. until dusk**
- Do not use if equipment is broken or wet. Contact the Hickory Hills Park District Maintenance Department at 708-598-1233 ext. 8.
- Skaters/bikers are responsible for inspecting equipment prior to using to ensure that it has not been vandalized and is safe for skating.
- Helmets, knee & elbow pads, wrist guards are required while skating/bikers.
- No ramps, boxes, etc. may be brought into the park.
- NO GLASS in any form allowed.
- No alcohol, drugs, tobacco or vaping allowed.
- All participants will refrain from acting in any manner which may cause or contribute to death or injury to themselves or to any other persons.
- All participants will act within the limits of their ability.
- Participants are allowed to skate/bike only inside the facility.
- Profanity, fighting or any disorderly conduct will result in expulsion from the skate park.
- Graffiti of any kind is not allowed, this includes but not limited to stickers, markers, and/or spray paint.
- All participants will maintain control of their equipment while skating. The park district is not responsible for lost/stolen equipment.
- Climbing fence to gain access is strictly prohibited. Violators will be subject to arrest.
- If rules are not followed, H.H.P.D. may elect to temporarily or permanently close the park.
- Park will be closed during inclement weather.
- Park sponsored programs have priority.

THE PARK DISTRICT IS NOT RESPONSIBLE FOR ANY LOST OR STOLEN ITEMS.

REFUND POLICY

• Refund requests for any class **MUST** be made Monday through Friday, 9 a.m. to 5 p.m., and at least 48 hours prior to the program's second meeting. After the program's second meeting, no refund will be issued.

• An administrative fee will be assessed on all credits or refunds. Credits will be charged a \$1 administrative fee, and all refunds by check will be charged a \$5 administrative fee.

Refunds for special events, one day program/events, and trips will be issued only if cancelled by the Park District.

• There will be a 30-day waiting period on all refunds. All refunds will be mailed. **No cash or credit card refund will be given.**

• Refunds/prize money checks not cashed within 180 days will be voided and considered a donation to the park district.

• T-shirts/Uniforms issued in a program cannot be returned/refunded for any reason.

• All deposits are non-refundable except when programs are cancelled by the park district.

• Any refunds totaling \$20 or less will automatically be applied to your household account unless the park district cancelled the program.

• No refunds will be issued if you owe a balance (this includes preschool & dance balances).

• If you paid for a friend or family member and are requesting a refund, the refund will be made out to the participant not the payee.

• Refunds will not be given for medical reasons/doctor notes.

NEW ARRIVAL

Are congratulations in order? The park would like to deliver a very special bib to your newborn son or daughter. To receive the gift, simply call the park district office at 708-598-1233, informing us of your new arrival. We'll send the gift directly to your home! CONGRATULATIONS!

PARK WATCH

We need your help to keep the parks clean, safe, and free of vandalism. If you find any broken equipment or have any other safety concerns about the facilities, please contact the park district at 708-598-1233. If you see vandalism occurring in the parks, please contact the police department at 708-598-1313. The park district is committed to providing a safe place for recreational activities and would prefer to enhance the quality of the parks rather than replace vandalized equipment. Thank you for your support in our efforts to provide the residents of the park district with quality park sites and facilities.

AMERICANS WITH DISABILITIES ACT (ADA)

Hickory Hills Park District complies with the ADA and will make reasonable accommodations to enable people with disabilities to participate in and enjoy recreation programs. If you have any questions about the park district's compliance, please call us at 708-598-1233. Special accommodations should be made a minimum of 3 weeks before the start date of the program during the registration process.

PARENTS NOTE

Parents are asked not to attend their child's class unless invited by the instructor. Our instructors welcome the opportunity to discuss concerns with parents before or after class, time permitting. We have found that parents and/or siblings distract from the quality of instruction. It is of equal importance that children have quality leisure time with their peers. Thank you for your cooperation.

Due to insurance regulations, children are not allowed in adult classes with parents. The Park District is also not responsible for children left unsupervised while a parent attends a class.

FAMILY MEMBER RATE POLICY

An immediate family member is defined as a husband, wife and/or child(ren) that is 24 years or younger, living in the same household.

GEESE UPDATE

Ducks and geese naturally feed upon aquatic plants, grains, insects and sometimes fish. Problems arise when they are fed unnatural foods. Please do not upset the delicate balance of nature **DO NOT FEED THE GEESE.**

PARK GUIDELINES

For your safety and protection, the Hickory Hills Park District Board of Commissioners have established certain rules so that everyone may enjoy the park safely. You are required to comply with the following guidelines: **All animals, with the exception of service animals, are prohibited in the parks.** Violations are subject to a minimum \$250 fine to a maximum of \$20,000 fine. All service animals must be leashed. Parks close according to posted signs.

The following are prohibited:

- Feeding the water fowl
- Drones/unmanned air crafts
- Driving on the grass or through the parks
- Alcoholic beverages
- Barbecuing
- Golfing

Please note that any violations may carry up to a \$250 fine.

THERE IS A LOCKED REGISTRATION DROP-BOX, ACCESSIBLE 24 HOURS A DAY, LOCATED TO THE LEFT OF THE MAIN ENTRANCE OF THE CYNTHIA NEAL ADMINISTRATION & RECREATION CENTER, 8047 W. 91ST PL.

BEHAVIOR/DISCIPLINE POLICY

The Hickory Hills Park District has a formal discipline policy for disruptive behavior during programs/classes. You may obtain a copy from the office. The Hickory Hills Park District reserves the right to dismiss a participant and/or volunteer for disruptive behavior. Participants and volunteers are expected to exhibit appropriate behavior at all times. The following guidelines were developed to make park district programs safe and enjoyable for all participants. Additional rules may be added at the discretion of the park district. Staff, participants and volunteers shall:

- Show respect for each other
- Refrain from using foul language
- Refrain from causing bodily harm to other participants, staff and volunteers
- Show respect for equipment and facilities.

PARK USAGE

Your family is welcome to play in the parks. Groups of 7 or more is considered a league and will need to get an athletic field permit. We do not allow setting up cones or painting lines unless you have a permit. You may see our fields are not used at times. This is due to keeping the grass and ball fields looking good for park district programs and leagues.

- No picnic rentals
- No catering meals
- No setting up of tables, chairs, inflatables, etc.
- Firearms are prohibited in any park, playground, and facility.
- No grilling
- No pets

ATHLETIC FIELD PERMIT

A permit is necessary for any formal or informal use of 7 or more people using our athletic fields. Permits will be issued according to availability beginning March 1, but not confirmed until April 1. For details on athletic fields call 708-598-1233 ext. 0. There are no picnic or park rentals/permits, except for the Krueger Park Picnic Shelter (weekends only).

ROOM RENTALS

Call 708-598-1233 ext. 0 for more information on building rentals.

TYPOGRAPHICAL ERRORS

All typographical and printing errors are subject to correction.

MSDS sheets are available on all products used by the Park District.

FITNESS CENTER

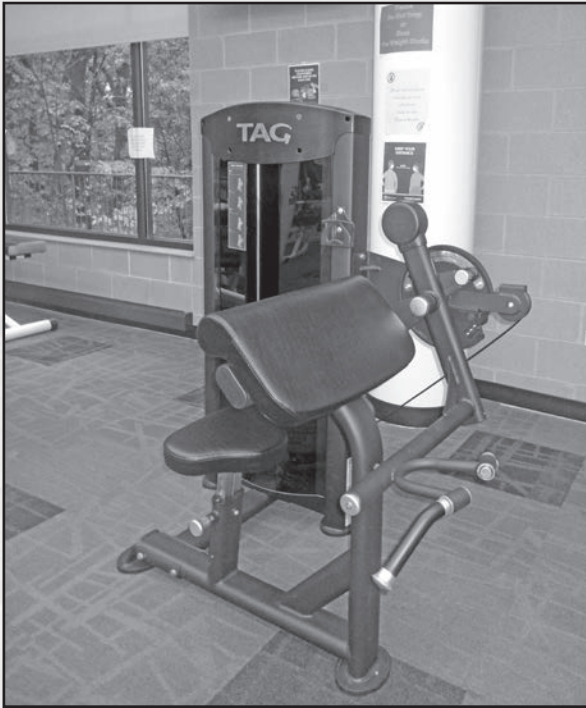

For more information on the fitness center see page 15

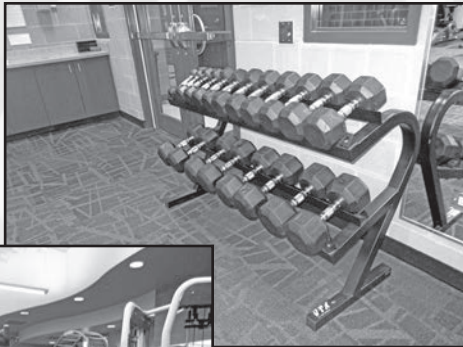

**RENTALS
AT THE
PARK DISTRICT**

The Hickory Hills Park District has limited activity room and field rentals available. A permit is necessary for any use of 7 or more people using our fields outdoors. Rentals are available at the Krueger Park picnic area and athletic fields for their corresponding sports.

For more information including pricing and availability, call 708-598-1233.



After School

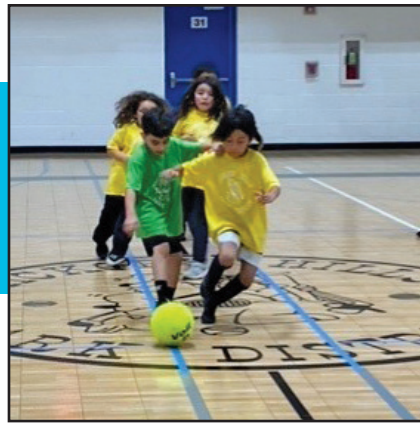

Soccer Program



MMA



Pickleball



Children's Christmas Party



Spring Garage Sale

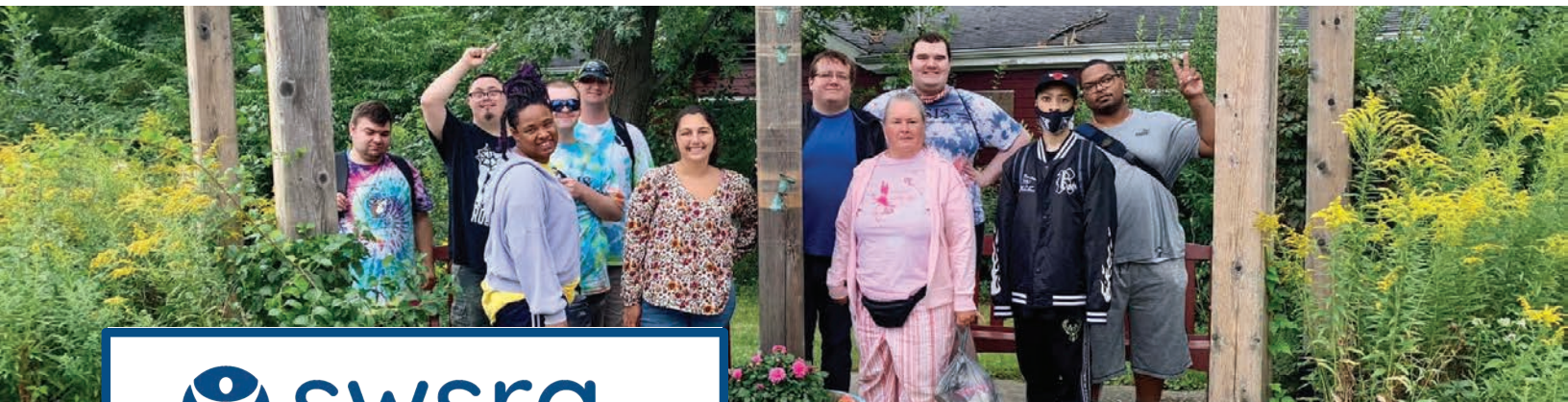

WHO WE ARE:

South West Special Recreation Association (SWSRA) was formed in 1981 to provide year-round quality therapeutic recreation programs and services for individuals with intellectual and/or physical disabilities or special needs. SWSRA programs are designed to increase independence and enhance the quality of life for each individual. SWSRA offers a variety of programming for ages youth to adult.

WHO WE SERVE

- Alsip Park District
- Blue Island Park District
- Hickory Hills Park District
- Village of Merrionette Park
- Midlothian Park District
- Palos Heights Parks & Recreation Department
- Posen Park District
- Worth Park District

AREAS OF SERVICE:

- Weekly Programs (in-person & virtual)
- Special Events
- Adult Day Program
- Special Olympics
- Cooperative Programs
- Inclusion Services
- Special Olympics

Follow us on...



"Building Community through Recreation"

12521 S. Kostner Ave.
 Alsip, IL 60803
 708-389-9423
 visit us at www.swsra.org

Hickory Hills Park District
8047 W. 91st Pl.
Hickory Hills, IL 60457

PRSR MKT
US POSTAGE PAID
BRIDGEVIEW, IL 60455
PERMIT NO. 154

ECRWSS
POSTAL CUSTOMER
HICKORY HILLS, IL 60457

Registration Information
Resident Registration Begins Monday, December 2
Non-Resident Registration Begins Monday, December 9

Congratulations!

Jennifer Fullerton On Your Retirement!



We appreciate your *20+ years* of service and all that you have done for the Hickory Hills Park District.

We will miss you!